

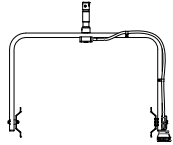

QTY	PART	DESCRIPTION	PART NO.
8		SCREW M5 10mm PAN PHIL SS BOX	2020127
1		POLE-YOKE ASSEMBLY w/ JUNIOR PIN (28mm)	7010022

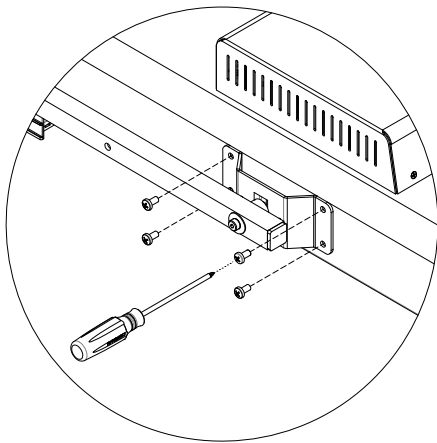

DETAIL A

WARNING: USE ONLY THE SCREWS PROVIDED.
IT IS NORMAL FOR THE SELF CLINCHING SCREWS TO BE TIGHT FITTING.
RECOMMENDED TORQUE SETTING:
USA: 18 Lb-In
METRIC: 2 Nm

