





QTY	PART	DESCRIPTION	PART NO.
8		SCREW M5 x 10 PAN PHIL SS BOX	2020127
1		POLE YOKE ASSEMBLY w/JUNIOR PIN (28mm)	7010012

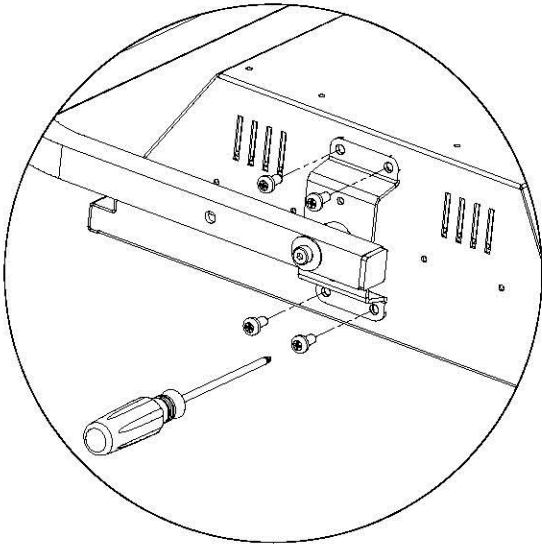

DETAIL A

WARNING: USE ONLY THE SCREWS PROVIDED.

IT IS NORMAL FOR THE SELF CLINCHING SCREWS TO BE TIGHT FITTING.

RECOMMENDED TORQUE SETTING:

USA: 18 Lb-In
METRIC: 2 Nm

