



**PRT-PWS-52**  
**DMX Power Supply Repair Kit**

Model Number	Chart
Image 20/DMX 120V	1
Image 20/DMX 230V	1
Image 40/DMX 120V	2
Image 40/DMX 230V	2
Image 45/DMX 120V	1
Image 45/DMX 230V	1
Image 80/DMX 120V	1
Image 80/DMX 230V	1
Image 85/DMX 120V	1
Image 85/DMX 230V	1
Select/DMX 4Bank 120V	1
Select/DMX 4Bank 230V	1
Mega/Dmx 4Bank 120V	1
Mega/Dmx 4Bank 230V	1
Parazip 200 120V	1
Parazip 200 230V	1
Parazip 400 120V	1
Parazip 400 230V	1
Parabeam 200 120V	4
Parabeam 200 230V	4
Parabeam 400S 120V	5
Parabeam 400S 230V	5
Vistabeam 300 120V	5
Vistabeam 300 230V	5
Vistabeam 600 120V	5
Vistabeam 600 230V	5
Koloris 150 120V/230V	2
Koloris 200 120V/230V	1
Multi-Flo DMX 120V	3
Multi-Flo DMX 230V	3
Wall-O-Lite 120V	6
Wall-O-Lite 230V	6

The Dmx Power Supply is used on many Kino Flo products. Each one has different wiring configuration.

Please refer to the model number and appropriate chart.



Part No. 6800144



TABLE 1 Reference

MODEL	A	B
Image 20/DMX 120V	BLK	WHT
Image 20/DMX 230V	BLK	WHT
Image 45/DMX 120V	BLK	WHT
Image 45/DMX 230V	BRN	BLU
Image 80/DMX 120V	BLK	WHT
Image 80/DMX 230V	BLK	WHT
Image 85/DMX 120V	BLK	WHT
Image 85/DMX 230V	BRN	BLU
Select/DMX 4Bank 120V	BLK	WHT
Select/DMX 4Bank 230V	BRN	BLU
Mega/DMX 4Bank 120V	BLK	WHT
Mega/DMX 4Bank 230V	BRN	BLU
Parazip 200 120V	BLK	WHT
Parazip 200 230V	BRN	BLU
Parazip 400 120V	BLK	WHT
Parazip 400 230V	BRN	BLU
Koloris 200 120V/230V	BLK	WHT

**Chart I**

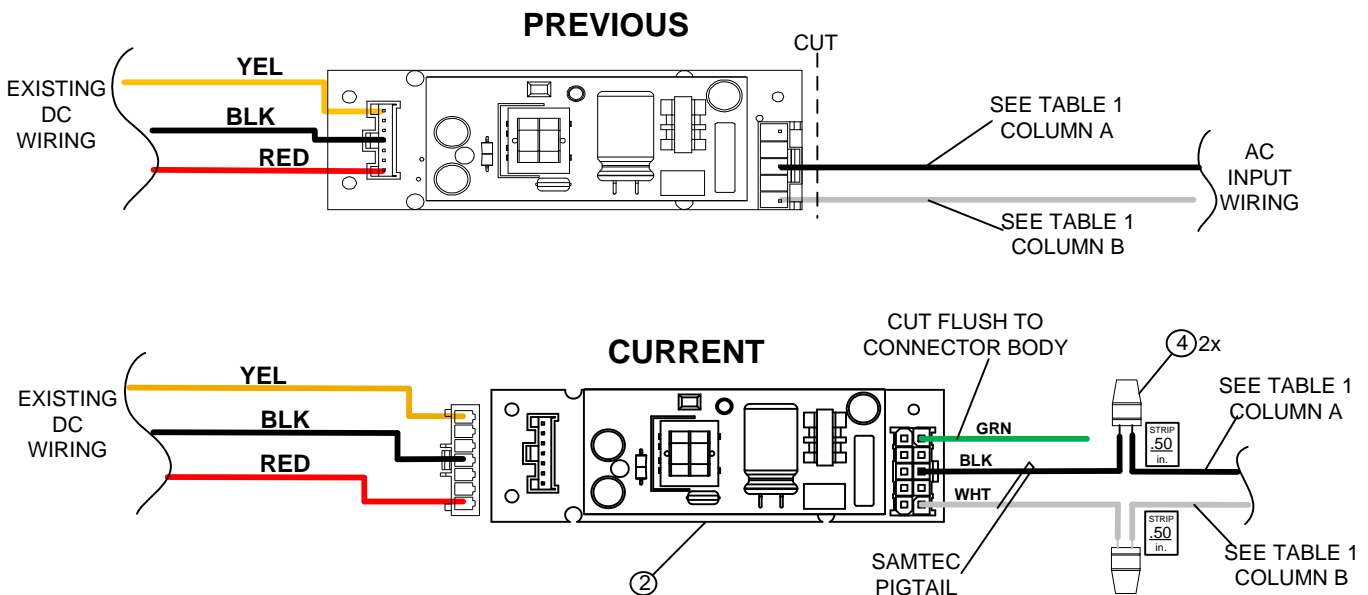



**Chart 2**

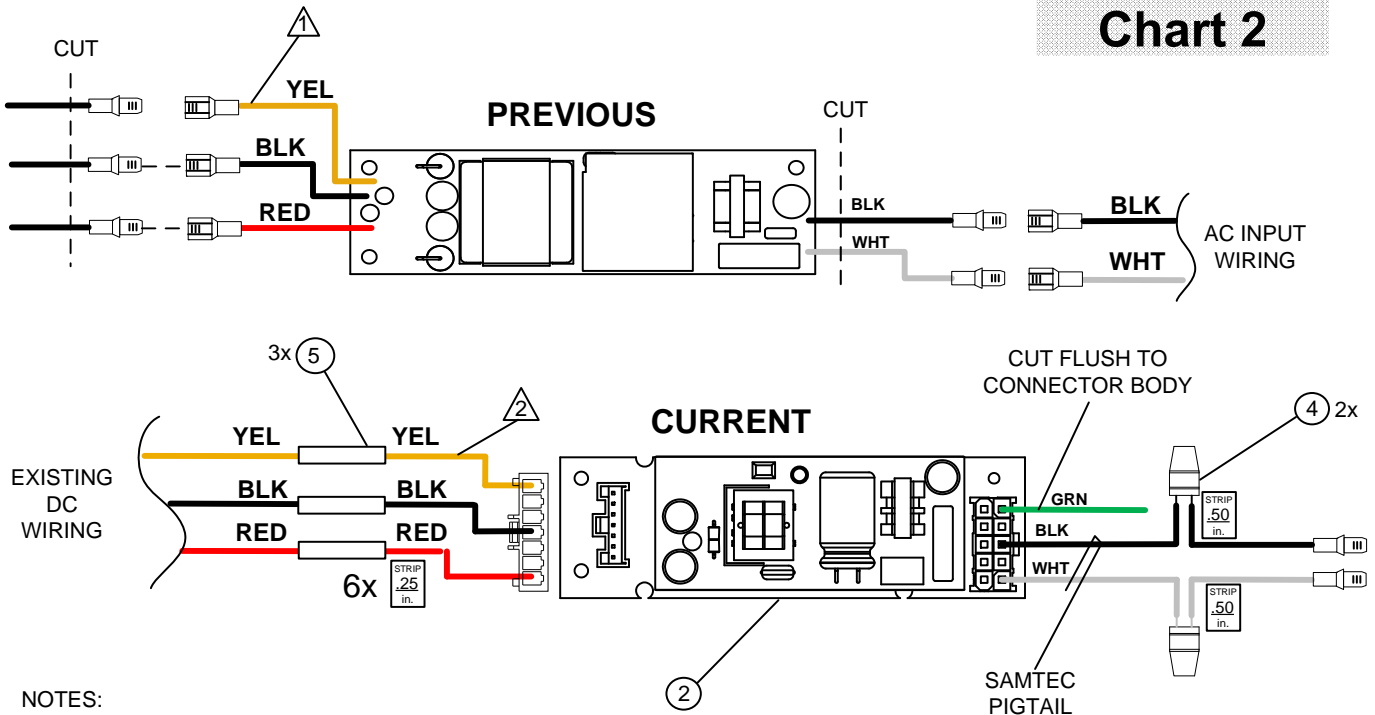

NOTES:

- ⚠ THIS WIRE NOT PRESENT ON KOLORIS 150
- ⚠ CUT YELLOW WIRE FLUSH TO CONNECTOR BODY WHEN USED ON KOLORIS 150

**MULTIFLO DMX 120V/230V**

**Chart 3**

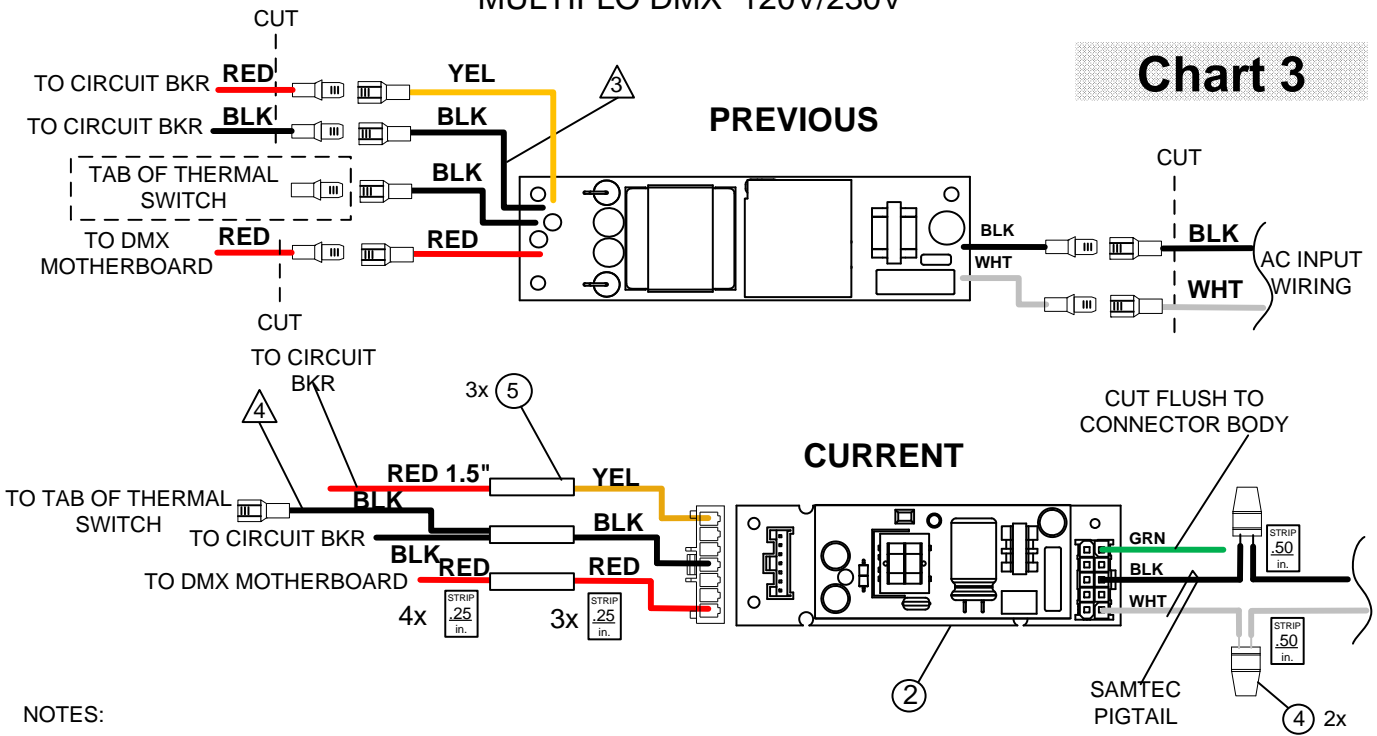

NOTES:

- ⚠ CUT THIS WIRE NEAR PCB AND RETAIN WIRE PIECE. WIRE PIECE USED WITH NEW POWER SUPPLY
- ⚠ CRIMP SAVED WIRE AND BLACK WIRE FROM CIRCUIT BREAKER TOGETHER



PARABEAM 200 120/230V

**Chart 4**

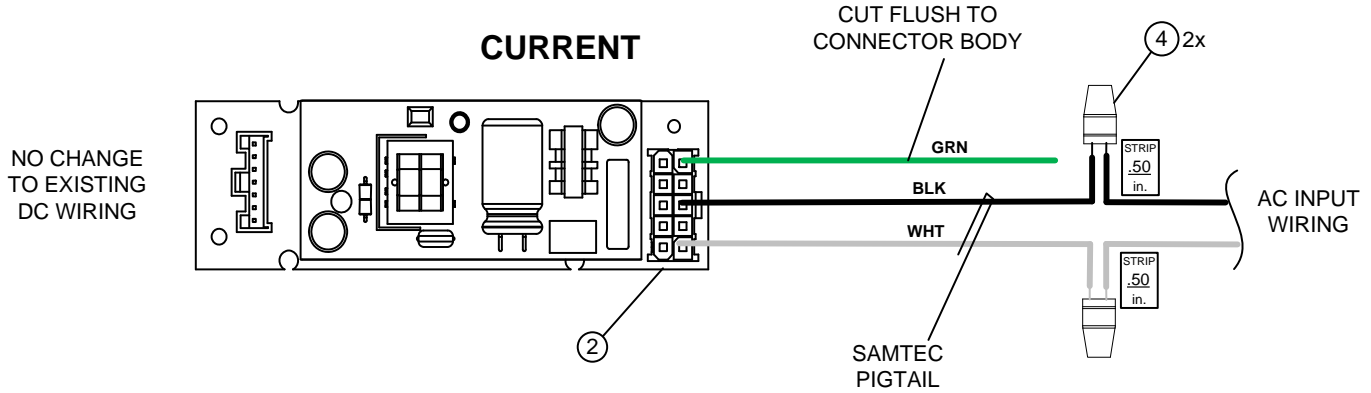
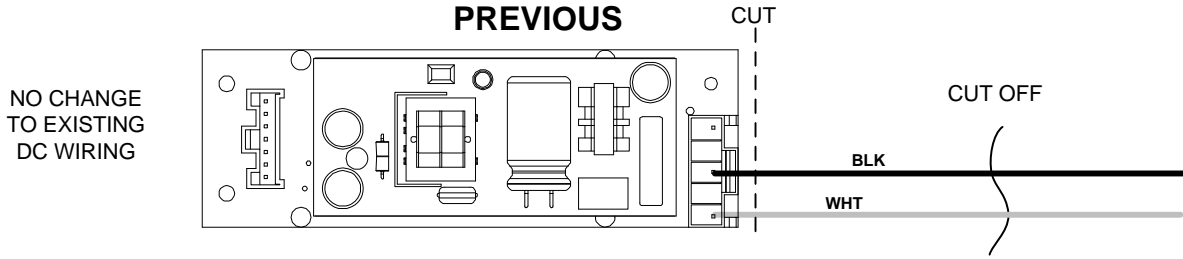

PARABEAM 400S 120/230V  
VISTABEAM 300 120/230V  
VISTABEAM 600 120/230V

**Chart 5**

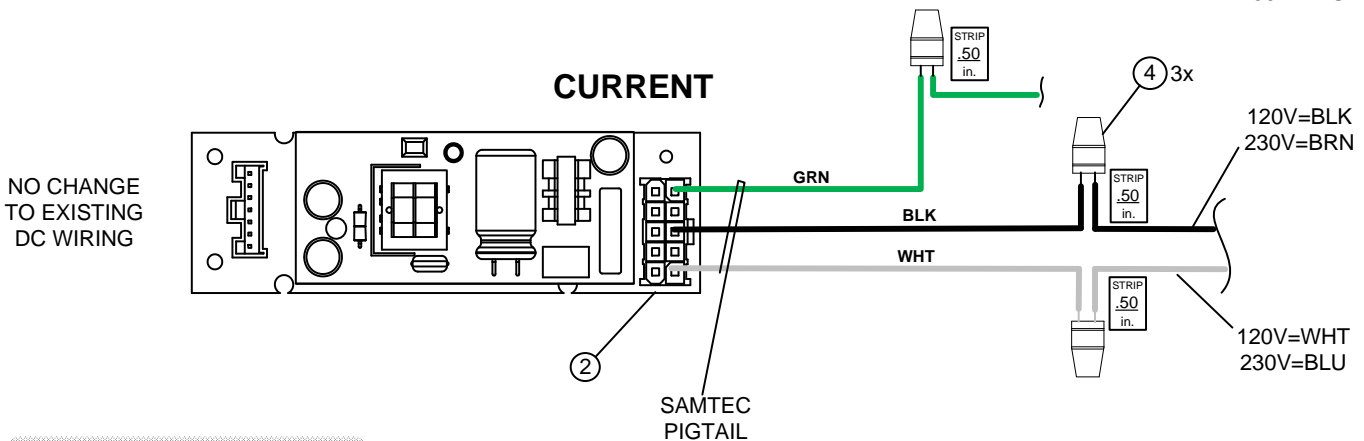
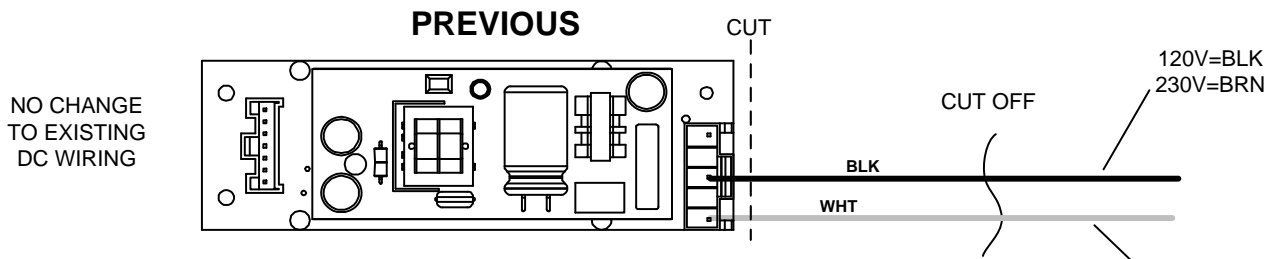

See page 6 for kit contents



**Chart 6**

**WALL-O-LITE 120V/230V**

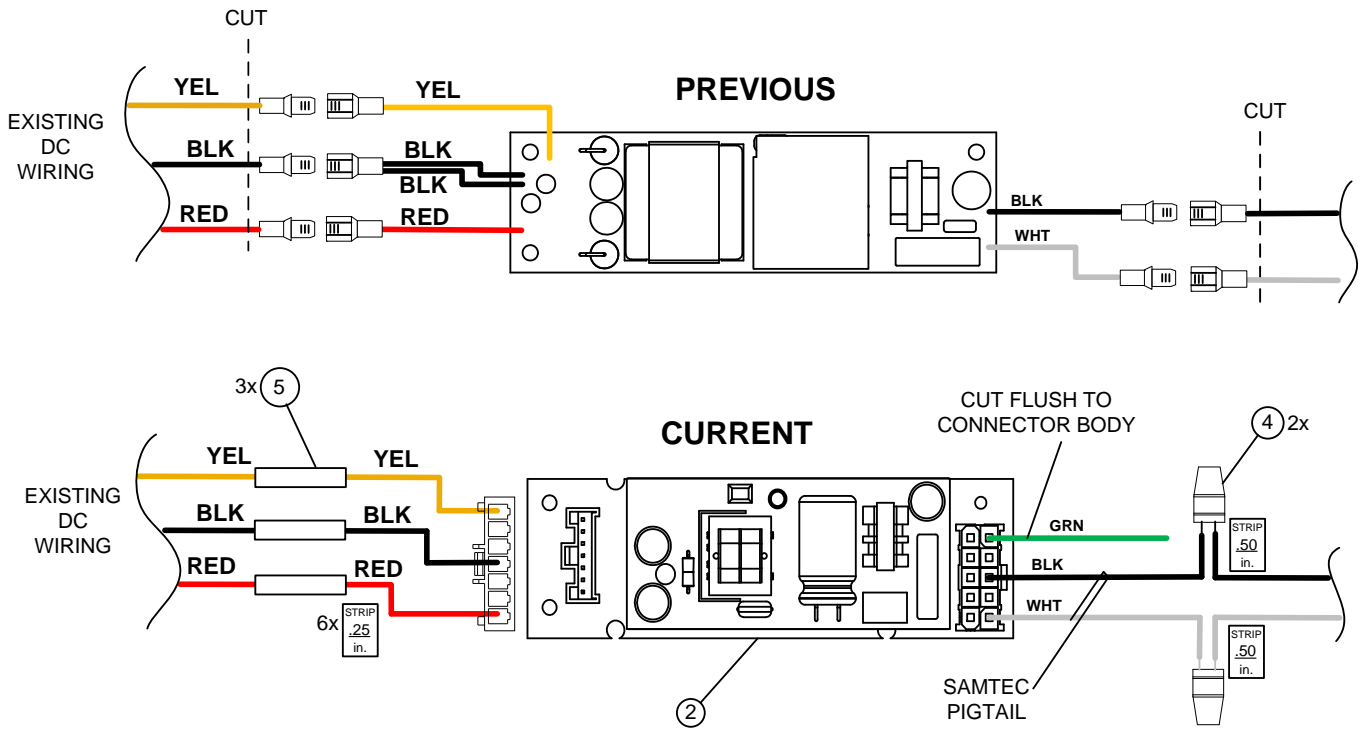



**Kit Contents**

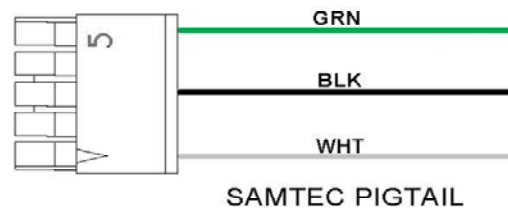
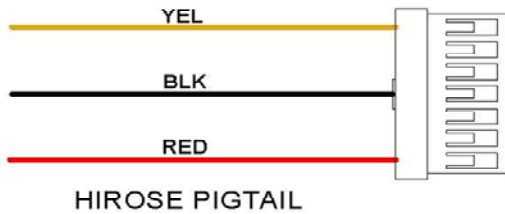
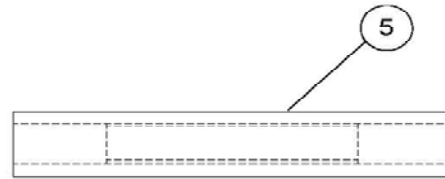
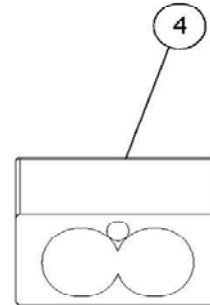
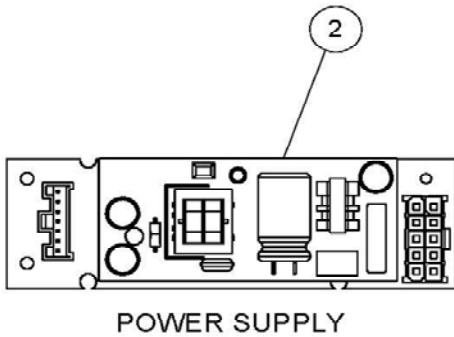

ITEM	P/N	QTY	DESCRIPTION
⚠ 1	3120036	1	INSTRUCTION, POWER SUPPLY MODIFICATION
2	6800144	1	PWS-5V-1A-12V-25MA-240V-SAMTEC-ROHS
⚠ 3	2100003	3	TIE CABLE 4" X .1" NY NAT
4	1260055	3	CN-SPLICE-PUSH IN-18 AWG-RED
5	1260056	3	CN-BUTT-INSUL-SLICE-26-22AWG-YELL

**NOTE:**

⚠ ITEMS NOT SHOWN BUT INCLUDED IN THE KIT