Operation Manual

4Bank DMX Select



System

4Bank



CFX-4804 4ft 4Bank Fixture
CFX-2404 2ft 4Bank Fixture



MTP-KL41 Kino 41L Mount w/ 3/8" Pin



X16-25 4Bank Extension, 25ft



BAL-450-120 Select/DMX 4Bank Ballast,
120VAC
BAL-450-230 Select/ DMX 4Bank Ballast,
230VAC

4Bank System consists of:

- 1 Fixture
- 1 Mounting Plate
- 1 Extension Cable
- 1 Select/DMX 4Bank Ballast

True Match® Lamps



488-K29-S 4ft Kino 800ma KF29
488-K32-S 4ft Kino 800ma KF32
488-K55-S 4ft Kino 800ma KF55

242-K29-S 2ft Kino 800ma KF29
242-K32-S 2ft Kino 800ma KF32
242-K55-S 2ft Kino 800ma KF55

Lighting Kits



Gaffer DMX Kit

KIT-2GF-X120

Gaffer DMX Kit, 120VAC (2-Unit)

KIT-2GF-X230

Gaffer DMX Kit, 230VAC (2-Unit)

Kit Contents:

2 4ft 4Bank DMX System w/ MTP-BL41 Mount
2 Lamp Case
1 Gaffer Ship Case

Dimensions

56.5 x 13 x 21.5"
(143.5 x 33 x 54.6cm)

Weight

76 lb (34.5kg)



Interview DMX Kit

KIT-2NT-X120

Interview DMX Kit, 120VAC (2-Unit)

KIT-2NT-X230

Interview DMX Kit, 230VAC (2-Unit)

Kit Contents:

2 2ft 4Bank DMX System w/ MTP-BL41 Mount
2 Lamp Case
1 Interview Ship Case

Dimensions

35.5 x 13 x 22.5"
(90 x 33 x 57cm)

Weight

63 lb (28.6kg)

Fixture Assembly

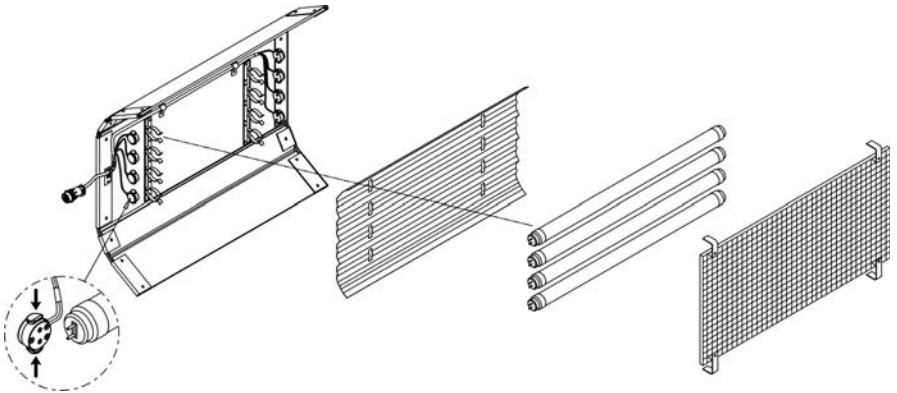

The 4Bank fixture is comprised of a removable Louver, Reflector, and Lamp Harness. The Louver and Reflector are held in place with Velcro fasteners. The Lamp Harness is secured by means of a ¼ turn fastener and two clips.

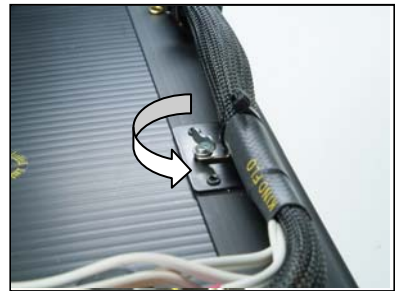
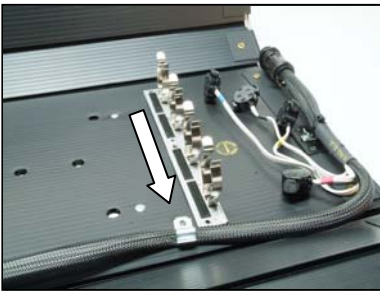

To Release the Lamp Harness

Remove the harness from 2 clips located under the reflector. Rotate the ¼ turn fastener clockwise to release harness.



The lamps can operate independent of the fixture allowing them to be built into sets or custom soft boxes or hand held as a single tube for an eye-light.

WARNING: Always use safety coated lamps to avoid injury if lamp breaks.

Lamp Harness Color Codes

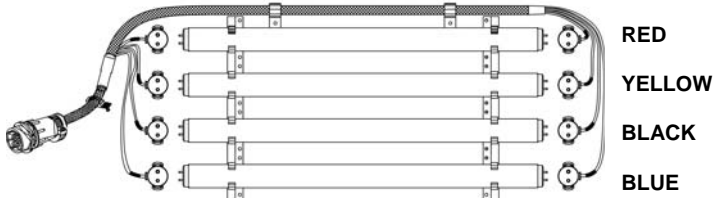

4Bank Harness

The Harness wiring is color-coded. The same color-code must match at each end of the lamp for proper operation.

Inserting Lamps



Locking Lamp Connector:

Depress both tabs on lamp connector and apply to lamp pins.
Match the Harness color-codes at each end of the lamp.
Push lamps into the fixture's Lamp Holder Clips.

Gelling the Fixture



Restricting the airflow around the lamps can cause the lamp to operate hotter. This increased heat will raise the lamp's color temperature and green spike. Therefore, it is recommended to clip gels to the Doors of the Fixture.

Do Not clip gels to louver.

Do Not block the fixture ends in a manner that restricts airflow.

Mounting the Fixture

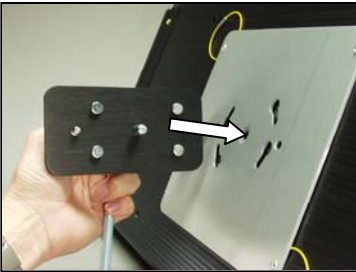

The standard mount (**MTP-KL41**) comes with a 3/8" Lollipop that clamps into a grip head. The ball and socket mount allows the fixture to be oriented in a broad range of angles.

Align the center pin of the mounting plate to the center hole on the mating plate.

Rotate plate clockwise until the four shoulder rivets drop into the receptacle. A locking pin will snap into place when the plate is properly seated.

The **yellow wire loops** provide attachment points for a safety chain.



To remove the plate, pull up on the locking pin and rotate the plate counter clockwise.

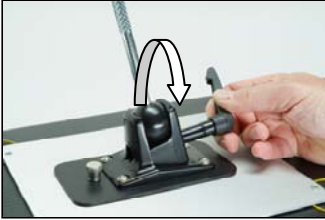

A 180° turn loosens the orientation of the mount.

A right turn tightens the mount.

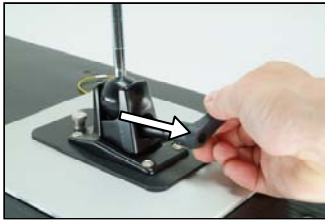

The tension on the lock lever may be adjusted by pulling the handle away from the mount.

This disengages the handle from the screw mechanism and allows the lever to be reoriented.



Lollipops are interchangeable.

MTP-L Kino 41 Lollipop w/ 3/8" Pin
MTP-LB Kino 41 Lollipop
w/ Baby Receiver
MTP-LBS Kino 41 Lollipop
w/ Baby Receiver Short

Other Fixture Mounting Options



The grommet holes along the edge of the fixture are designed to allow the fixture to be screwed onto set walls.



Extension Cable



To insert the cable, align the key ways on the extension cable with the circular receptacle on the ballast. Rotate the locking ring until it clicks into the lock position. Lamps can operate as far as 75 feet from the ballast. (3 x 25ft extensions)



A Splitter can be used at the Ballast or on the end of an Extension Cable to split a 4Bank run into either 4 Singles or 2 Doubles.

This allows for greater rigging flexibility.

Ballast Operation

WARNING!

- 1) ALWAYS TURN OFF THE BALLAST BEFORE connecting or disconnecting Lamps, Harnesses or Extension Cables.
- 2) Use only with Sine wave inverters. Do not operate on SCR dimmers.
- 3) If powering the ballasts through a Dimmer Pack set the Dimmer to Non-Dim Mode.

The 120VAC Ballast requires 110 to 130 Volts AC 50/60 Hertz on an earth grounded circuit; the 230VAC Ballast requires 220 to 240 Volts AC on an earth grounded circuit. The electronic Ballast operates at a high frequency of 25kHz. It is dead-quiet, instant-on and lightweight.

Load Considerations:

Kino Flo ballasts are not power factor corrected. They will draw double the current on the neutral from what is being drawn on the two hot legs. On large installations it may be necessary to double your neutral run so as not to exceed your cable capacity.

Ballast Operation Continued....

Cold Temperature Operation

The Select DMX Ballast series is designed to operate at temperatures from 14F to 122F (-10C to +50C). In cold temperatures, the Ballast may not strike the lamp(s) instantly. Switch the Ballast to OFF, wait seven seconds and try again.

If the Ballast does not strike after two or three attempts, turn off the Ballast, check that the Extension and Harness connections are secure and re-strike. Once operating for a few minutes, the Lamps should re-strike instantly.

Manual Operation

The Ballast operates remote from the fixture. Connect the Extension cable to the Ballast and the Lamp Harness. After the lamps are properly installed the Ballast can be turned on. Each switch controls one lamp. The color bands on the lamp harness correspond to the switches as illustrated.

Color Band

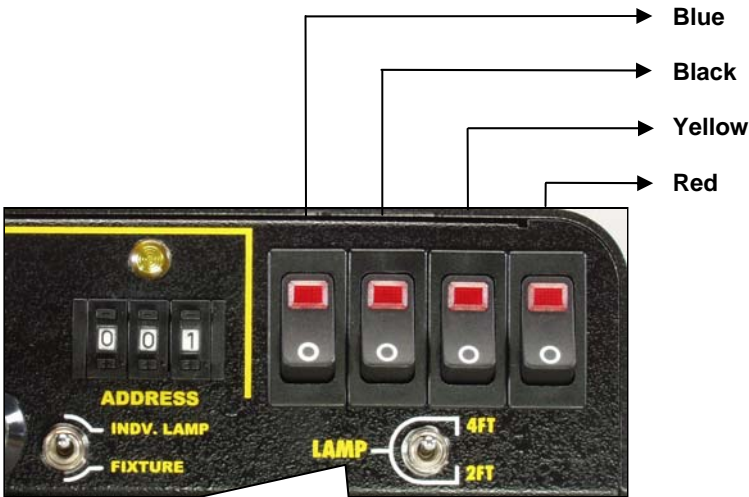

Lamp Select Feature

The Select Ballasts have a **4ft / 2ft** switch. Set the Selector Switch to **4ft** for 4ft lamps and **2ft** for 2ft or 15" lamps.

Lamp Select feature continued...

When operating 4ft lamps in high ambient temperature or where the units are rigged into place with restricted airflow, the **2ft** setting can be used to lower the color temperature and remove any green spike. The light drops about a half an f-stop in exposure when dropping from **4ft** to **2ft**.

It is not recommended to operate 2ft lamps in the **4ft** setting. At the **4ft** setting, the color temperature of the 2ft lamps will rise dramatically and experience a high green spike.

Select DMX 4Bank Control Panel

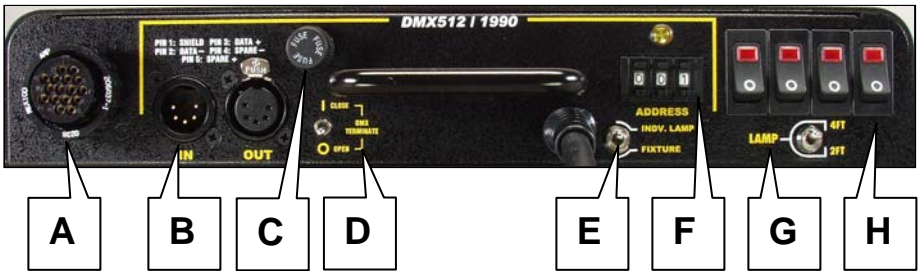

- A) **Circular Output Connector:** Provides electrical power to the lamp head with the use of a 4Bank extension cable.
- B) **DMX-In & DMX-Out:** DMX-IN receives DMX signals from Dimmer Board. DMX-OUT relays DMX signal through to other Fixtures or Instruments.
- C) **Fuse:** Provides circuit protection. *Note: If Fuse is "blown" or "open" replace with same type of fuse rating as marked.*
- D) **DMX TERMINATE Switch:** Terminates DMX signal at the end of Fixture series.
- E) **Individual Lamp / Fixture Switch:** Converts between INDIVIDUAL LAMP and FIXTURE methods of DMX control.
- F) **DMX Address:** Sets DMX Address of Fixture.
- G) **Lamp Select:** Set to **4ft** for 4ft lamps and **2ft** for 2ft or 15" lamps.
- H) **Manual Switches:** Turns lamps on and off manually.

DMX Operation

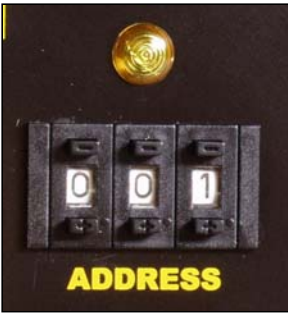

IMPORTANT!

The dimmer board/light console should have its channel set to LINEAR light output response. (LINEAR response is the default setting on most dimmer boards.)

DMX Addressing

Push the tabs above or below the number window to set the address.

(Valid addresses range from 001 to 512.)

The yellow light above the address block will illuminate if a DMX signal is present.

Each DMX 4Bank ballast operates on 5 addresses.

After the DMX address is entered, the ballast automatically assigns the next 4 addresses to lamps 2,3,4 and a 5th address controls the 2ft setting. Programming the 5th address at full dimmer setting activates the 2ft setting.

Note: When DMX cables are applied the manual 4ft/2ft select feature will be disabled.

To get manual control of the 4ft/2ft feature

- 1) Unplug the DMX cable or
- 2) Leave cables plugged in and set address to "000". There is a 5 second delay when switching between DMX and Manual control.

Manual lamp switching is not affected by DMX control.



The **DMX Terminate Switch** must be set to open (**O**) on Ballasts within the DMX chain.

Set to closed (**I**) when the Ballast is the last DMX control device in the chain.

Note: When the last Ballast's DMX Terminate Switch is set to "I", it will absorb all energy in the DMX line, ensuring DMX signals are transmitted correctly. If a signal is not terminated, it is called a "Reflected Wave", and may create transmission errors by causing valid DMX signals to be canceled.



Any theatrical lighting board with DMX512 protocol can be used to individually turn **on/off** lamps in a Fixture.

Select/DMX 4Bank Ballasts can be jumpered using the IN and OUT ports. As many as 100 Ballasts can be jumpered on one chain as long as the DMX cable run remains under 1000 feet or 40 x 25ft DMX cables.

Note: When operating Ballasts at great distances from the dimmer board, it is recommended to use Opto-Isolators to provide DMX signal amplification.



DMX Cables

The Fixture uses five-pin XLR male and female connectors to receive DMX signals from the Dimmer Board and jumper the Fixtures in a series. DMX pin-out wiring follows the USITT DMX512 standard:

- Pin 1: Shield**
- Pin 2: Data -**
- Pin 3: Data +**
- Pin 4: Spare -**
- Pin 5: Spare +**

Note: Pin four and five in the Fixture are connected internally as Pin four to four and Pin five to five. Connecting Pin four and five as the pass-thru allows secondary data to be passed through for other equipment.

Do Not use Microphone Cables and other, general purpose, two-core Cables designed for audio or signaling use. They are not suitable for DMX512. Problems due to incorrect cabling may not be immediately apparent. Microphone Cables may appear to work fine, but systems built with such Cables may *fail* or be prone to *random errors*. Cable must comply with EIA-485 (RS485).

NOTE: If a Fixture or Ballast loses its DMX signal it will hold its last DMX command. For this reason it is important to turn a Fixture or Ballast off using the DMX commands. For example, if you try to turn off the lights by turning off the dimmer board, the lights will remember their last DMX command and stay on. The Fixtures or Ballasts require a DMX "Off" or "Black-out" command in order to turn off.

Fixture Mode

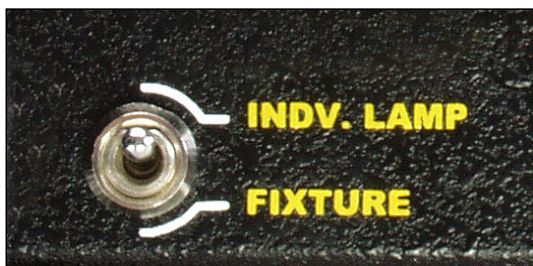

Setting the unit to **Fixture** mode allows the user to turn lamps on and off with an “inside-out” pattern from a dimmer board.

One of the best applications for the **Fixture** mode is when lighting Blue and Green Screens or large Cycloramas.

For example: One row of fixtures can be set to **Fixture** mode on a common address. When the fader on the dimmer board is brought up or down all the Fixtures on that address will have the same lamps turned on.

Dimmer level - Lamp response

Each ballast has 5 addresses. Addresses 001-004 control the lamps. Sliding the fader on the dimmer board from 0 ~ 100 controls the number of lamps that are on within a fixture. Address 005 controls the **2ft** setting.

Note: The lamps may respond ± 4 channel levels, depending on the dimmer board. To control the **2ft** select feature, program the 5th address (005) at full. Setting the dimmer value under 49% or not programming address 5 will restore the **4ft** setting.

4Bank Lamp Sequence

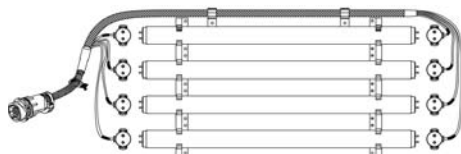

4 (Red)
2 (Yellow)
1 (Black)
3 (Blue)

DMX Lamp Sequence

Lamp #	Dimmer Level
Lamp 1	12
Lamp 1~2	37
Lamp 1~3	64
Lamp 1~4	83

To Control Light Levels From Multiple Fixtures:

- 1) Set ballast to **Fixture** mode.
- 2) Set all ballast addresses to a common address (e.g. 001).
- 3) Set address 005 if the **2ft** setting is required.
- 4) Set end of line switch to “I” on the last unit in the DMX chain.

Individual Lamp Mode

Setting the unit to **Individual Lamp** mode allows each lamp within the fixture to have its own address. Although this option will use up a lot of addresses, it may be preferable for certain situations.

The **Individual Lamp** mode is useful in achieving light effects like flickering, chasing or creating light patterns. Individual lamps or fixtures can be rigged into a set by using a 4Bank to Single or Double splitter. A Single splitter can provide 4 individual cable feeds to lamps or fixtures in a set. (For parts see page 16).

After the DMX address is entered, the Select/DMX 4Bank automatically assigns the next 4 addresses to lamps 2, 3, 4 and the 5th address controls the **2ft** setting. On address 5 to activate the **2ft** lamp setting, set dimmer slider to full. Setting the dimmer value under 49% or not programming address 5 will restore the **4ft** setting.

Note: The **4ft/2ft** select setting controls all 4 lamps equally. Individual settings per lamp are not possible.

For example, if the DMX 4Bank base address is set at 001 the configuration below will provide 4 lamps individually addressable through DMX512.

4Bank Lamp Sequence



4 (Red)
2 (Yellow)
1 (Black)
3 (Blue)

DMX Address Sequence DMX address 001	
Lamp#	DMX Address
Lamp 1	1
Lamp 2	2
Lamp 3	3
Lamp 4	4
2ft Setting	5

To Chase one lamp through multiple fixtures:

- 1) Set ballast to **Individual Lamp** mode.
- 2) Set each ballast with its own address: 001, 006, 011, 016 and so on.
- 3) Program address 005, 010, 015 etc. for **2ft** operation.
- 4) Program lamp sequence to chase from 001 through 004, 006-009, 011-014 and so on.
- 5) Set end of line switch to "I" on the last unit in the DMX chain.

To Chase same lamp position simultaneously through multiple fixtures:

- 1) Set ballast to **Individual Lamp** mode.
- 2) Set each ballast address to 001 (or a common address).
- 3) Program address 005, 010, 015 etc. for **2ft** operation.
- 4) Program lamps to chase from address 001-004.
- 5) Set end of line switch to "I" on the last unit in the DMX chain.

System Components



CFX-4804 4ft 4Bank Fixture
CFX-2404 2ft 4Bank Fixture



MTP-KL41 Kino 41L Mount w/ 3/8" Pin



X16-25 4Bank Ext. Cable, 25ft
X16-12 4Bank Ext. Cable, 12ft



BAL-450-120 Select/DMX 4Bank, 120VAC
BAL-450-230 Select/DMX 4Bank, 230VAC

True Match® Lamps



488-K29-S 4ft Kino 800ma KF29
488-K32-S 4ft Kino 800ma KF32
488-K55-S 4ft Kino 800ma KF55

242-K29-S 2ft Kino 800ma KF29
242-K32-S 2ft Kino 800ma KF32
242-K55-S 2ft Kino 800ma KF55

Accessories and Parts



MTP-BL41 Kino 41L Mount
w/ Baby Receiver
MTP-BL41S Kino 41L Mount
w/ Baby Receiver Short



MTP-L Kino 41 Lollipop w/ 3/8" Pin
MTP-LB Kino 41 Lollipop w/ Baby Receiver
MTP-LBS Kino 41 Lollipop w/ Baby Rcvr Short



MTP-BAL Kino Ballast Baby Mount



DFS-4804 4ft 4Bank Flozier, Full
DFS-4804-H 4ft 4Bank Flozier, Half

DFS-D4 2ft 4Bank Flozier, Full
DFS-D4-H 2ft 4Bank Flozier, Half



FIX-4804 4ft 4Bank Fixture Shell
FIX-2404 2ft 4Bank Fixture Shell



LVR-4804-B 4ft 4Bank Louver, Black
LVR-2404-B 2ft 4Bank Louver, Black



REF-4804 4ft 4Bank Reflector
REF-2404 2ft 4Bank Reflector



X16-A4 4Bank to Single Splitter
X16-A9 4Bank to Double Splitter



X09-25 Double Ext. Cable, 25ft
X09-12 Double Ext. Cable, 12ft

X04-25 Single Ext. Cable, 25ft
X04-12 Single Ext. Cable, 12ft



HAR-4804 4ft 4Bank Harness
HAR-2404 2ft 4Bank Harness

HAR-4802 4ft Double Harness
HAR-2402 2ft Double Harness

HAR-4801 4ft Single Harness
HAR-2401 2ft Single Harness

Expendables



EXP-LHC-T12 Lamp Holder Clips T12, 24pk



EXP-M&T Adhesive Mounts and Releasable Ties, 25pk



PRT-HLC Kino Locking Lamp Connector, 1pk

See web site: www.kinoflo.com for more accessories.

Lamp w/ Harness Specifications

Kino Flo Lamp w/ Harness Dimensions

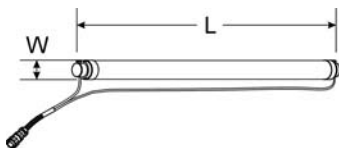

Lamp Type	Length	Width
2ft Med. Bi-Pin	24.5"	1.5"
4ft Med. Bi-Pin	48.5"	1.5"

Fixture Specifications

Kino Flo 4Bank Fixture Dimensions

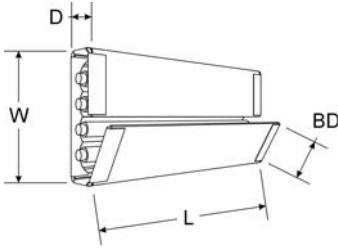

Fixture Style	Length	Width	Depth	Barndoor		Weight w/Lamps
				Width	Weight	
2ft 4Bank	27.00"	13"	3.5"	6.5"	7.5 lbs	7.5 lbs
4ft 4Bank	52.00"	13"	3.5"	6.5"	11.5 lbs	11.5 lbs

Kino Flo Double Fixture Dimensions

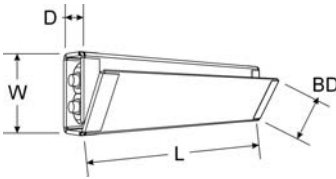

Fixture Style	Length	Width	Depth	Barndoor		Weight w/Lamps
				Width	Weight	
2ft Double	27.00"	7.5"	3.5"	6.0"	4.7 lbs	4.7 lbs
4ft Double	52.00"	7.5"	3.5"	6.0"	7.7 lbs	7.7 lbs

Kino Flo Single Fixture Dimensions

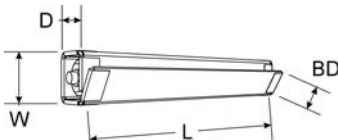

Fixture Style	Length	Width	Depth	Barndoor		Weight w/Lamps
				Width	Weight	
2ft Single	27.00"	4.5"	3.5"	3.5"	2.7 lbs	2.7 lbs
4ft Single	52.00"	4.5"	3.5"	3.5"	4.3 lbs	4.3 lbs

Cases



KAS-C46



KAS-54L



KAS-KFC



BAG-201

Part Number	Description	Dimensions	Weight (Empty)	Holds
BAG-201	2ft 4Bank Soft Case	27.5 x 7 x 18" (70 x 18 x 46cm)	3.3lb / 1.5kg	2ft 4Bank System (1), Lamp Case
BAG-401	4ft 4Bank Soft Case	53.5 x 7 x 18" (136 x 18 x 46cm)	5lb / 2.3kg	4ft 4Bank System (1), Lamp Case
INS-L4	4-Lamp Foam Pad	24 x 9 x 1" (61 x 23 x 2.5cm)	N/A	Fits KAS-48, 72, 96
INS-L6	6-Lamp Foam Pad	24 x 13 x 1" (61 x 33 x 2.5cm)	N/A	Fits KAS-54S, 54L, 96L
KAS-21	2ft System Ship Case	30 x 10 x 15" (76 x 25.5 x 38cm)	12.5lb / 5.6kg	2ft 4Bank System (1)
KAS-41	4ft System Ship Case	57 x 9.5 x 15" (145 x 24 x 38cm)	25lb / 11.3kg	4ft 4Bank System (1)
KAS-48	4ft Lamp Ship Case	52.5 x 10.5 x 11" (133.5 x 26.5 x 28cm)	15.5lb / 7kg	4ft Lamps (20)
KAS-54L	4ft Fixture Ship Case, Large	57 x 15 x 17" (145 x 38 x 43cm)	25lb / 11.3kg	4ft 4Bank Fixture (5)
KAS-54S	4ft Fixture Ship Case, Small	57 x 15 x 11.5" (145 x 38 x 29cm)	21lb / 9.5kg	4ft 4Bank Fixture (3)
KAS-C26	6-Lamp Carry Case, (2ft)	26.5 x 6 x 4" (67.5 x 15 x 10cm)	1lb / .5kg	2ft Lamps (6)
KAS-C46	6-Lamp Carry Case, (4ft)	50.5 x 6 x 4" (128.5 x 15 x 10cm)	1.5lb / .7kg	4ft Lamps (6)
KAS-GAF2	Gaffer Kit Ship Case	56.5 x 13 x 21.5" (143.5 x 33 x 54.6cm)	31lb / 14kg	4ft 4Bank System (2), Lamp Case (2)
KAS-INT2	Interview Kit Ship Case (2)	35.5 x 13 x 22.5" (90 x 33 x 57cm)	25lb / 11.3kg	2ft 4Bank System (2), Lamp Case (2)
KAS-INT3	Interview Kit Ship Case (3)	35.5 x 13 x 23.5" (90 x 33 x 59.7cm)	25.5lb / 11.5kg	2ft 4Bank System, 2ft Double System (2) Lamp Case (2)
KAS-KFC	Ballast & Cable Crate w/ Lid	21.5 x 15 x 12" (54.5 x 38 x 30.5cm)	6lb / 2.7kg	Ballasts, Cables, Mounting Plates

Ballast Specifications



BAL-450-120

Select/DMX 4Bank Ballast, 120VAC

Input Voltage: 120VAC 50/60Hz

Output Frequency: 25kHz

Amperage: F75/4.6A, F40/3.2A, F30/2.5A

Lamp switching: 4-1/off

Output Switching: 4ft / 2ft

Ballast size: 12.5 x 12.5 x 2.5"
(32 x 32 x 6.5cm)

Weight: 6.5lb / 2.9kg

BAL-450-230

Select/DMX 4Bank Ballast, 230VAC

Input Voltage: 230VAC 50/60Hz

Output Frequency: 25kHz

Amperage: F75/2.4A, F40/1.7A, F30/1.3A

Lamp switching: 4-1/off

Output Switching: 4ft / 2ft

Ballast size: 12.5 x 12.5 x 2.5"
(32 x 32 x 6.5cm)

Weight: 6.9lb / 3.1kg

For latest Warranty information and Certifications,
see Kino Flo website at www.kinoflo.com.

Environmental: Disposal of Old Electrical & Electronic Equipment.



This symbol on the product or on its packaging indicates that this product shall not be treated as household waste. This product is made of recyclable materials and should be disposed of in accordance with local and state regulations.

Kino Flo, Inc. 2840 N. Hollywood Way, Burbank, CA 91505, USA
Tel: 818 767-6528 website: www.kinoflo.com